



PRIVATE JOINT STOCK COMPANY "KHEMZ-IPEC" Submersible Equipment for Oil Production



**Pumps
Electric motors
Water protection**





“KhEMZ–IPEC”, Private Joint Stock Company, was founded in 1995 by the State Property Fund of Ukraine and investment company International Petroleum Company, Inc., on the basis of production facilities of Kharkov Electromechanical Plant which for more than a half of century had been manufacturing submersible electric motors used to drive centrifugal pump plants.

Thanks to purposeful investment policy, “KhEMZ–IPEC”, PrJSC, became a modern high-technology enterprise with closed manufacturing cycle for of submersible centrifugal pumps, and output of submersible asynchronous electric motors in quantity of up to 3000 units per year. The Enterprise territory is 2.93 ha, including production premises having area of about 22000 м2. In its production activities, the Enterprise uses more than 550 machine-tools, tens of testing stands, stations and testing and manufacturing plants.



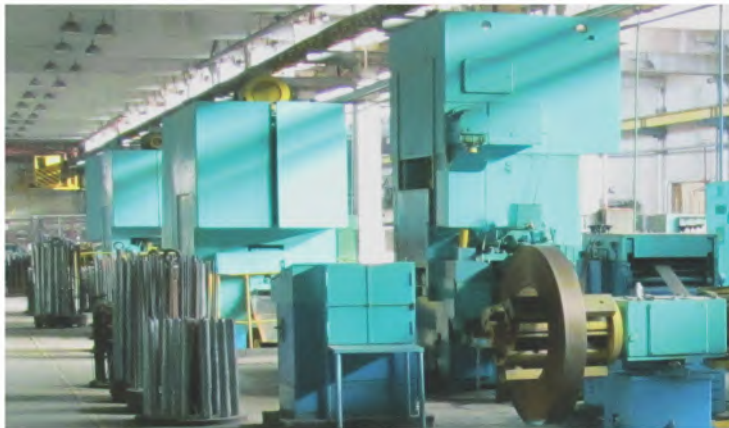

Our Plant has blanking, stamping, machining, heat-treating, impregnation, winding, painting, assembly and reinforcing sectors, testing stations, repair units, tool-making and woodworking facilities. KhEMZ–IPEC”, PrJSC, is certified according to ISO-9001 system.

In 2002, “KhEMZ–IPEC”, PrJSC, started delivery of new “M5”series of retrofitted electric motors using stator magnetic circuit with 24 closed slots and impregnating varnish (compound), having enhanced electrically insulating properties and heat resistance. The electric motor comes complete with single-housing motor protector.

Since 2006, KhEMZ–IPEC PrJSC basing on its developments, launched manufacture of submersible centrifugal pumps with pump housing diameter of 92 mm and rated delivery of 50, 80 and 125 m³/day and head of 1100 to 3050, and since 2015, centrifugal pumps are manufactured with housing diameter of 92 mm and rated delivery from 25 to 200 m³/day and range of heads from 290 to 4,000 m.





The stand for acceptance of centrifugal pumps provides conducting tests in compliance with GOST 6134-87. The stand for periodical testing centrifugal pumps provides conducting tests for conformity of centrifugal pumps to the technical requirements of GOST 6134-87. The stands for acceptance of electric motors provide conducting tests in compliance with DSTU 2649-94, GOST 11828-86, GOST 7217-87 and GOST 183-74.

The stand used to check tightness provides check for tightness in compliance with DSTU 2649-94. The vibration stand for electric motor diagnostics provides test for vibration of electric motors in inclined positions according to the requirements of ISO 10816-1-97. The automated stand for periodical testing electric motors provides conducting tests for conformity of electric motors to the technical requirements of DSTU 2649-94, GOST 11828-86, GOST 7217-87, GOST 183-74 and GOST 25491-83.



ELECTRIC CENTRIFUGAL PUMPS



The multistage submersible centrifugal pumps of vertical version (electric centrifugal pumps), driven from submersible asynchronous electric motors with continuous mode of operation S1 to GOST 183 from AC mains with frequency of 50 Hz (motors), are used for pumping out formation fluid (oil, associated water and associated gas) from oil wells with deflection angle in the place of suspension not more than 60° .

The rated values of environmental climatic factors during operation shall meet version B* to GOST 15150.

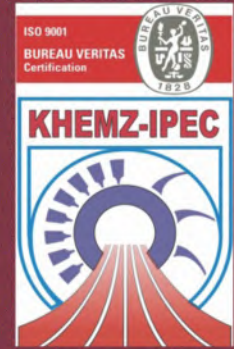



ELECTRIC CENTRIFUGAL PUMPS

The electric centrifugal pumps consist of the following assembly units:

- centrifugal pump including lower section with input module, upper section (including check valve, drain valve, sludge trap), one or several intermediate sections;
- motor including one or several electric motors (sections) and motor protector.

The following reliability parameters are specified for electric centrifugal electric pumps:

- mean time to failure – 17500 hours;
- mean time to overhaul – 19000 hours;
- mean service life – 5 years;
- shelf life – 24 months.

The guaranteed operation period is 18 months from the date of putting into operation within guaranteed shelf life.

The structure of type conventional designation for electric centrifugal pumps, centrifugal pumps, motors, electric motors and motor protectors are presented in Appendix to this Catalog.



CENTRIFUGAL PUMPS



Range of manufactured pumps

The centrifugal pumps are manufactured with housing diameter of 92 mm and rated delivery of 25, 30, 50, 80, 125 and 200 m³/day.

Range of heads of centrifugal pumps with rated delivery of 25 m³/day: 600 to 3600 m.

Range of heads of centrifugal pumps with rated delivery of 30 m³/day: 530 to 3250 m.

Range of heads of centrifugal pumps with rated delivery of 50 m³/day: 560 to 3450 m.

Range of heads of centrifugal pumps of rated delivery of 80 m³/day: 580 to 3600 m.

Range of heads of centrifugal pumps of rated delivery of 125 m³/day: 480 to 2950 m.

Range of heads of centrifugal pumps of rated delivery of 200 m³/day: 290 to 2400 m.

On the Customer's request, the centrifugal pumps with extended range of heads and with various rated deliveries may be manufactured as well.

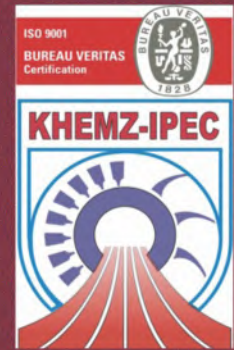



CENTRIFUGAL PUMPS

Medium where centrifugal pumps are to be operated

Parameter	Unit of measurement	Value for modification			
		Version			
		standard	heat-resistant	wear-resistant	heat- and wear-resistant
Maximum density of formation fluid	kg/m ³	1400	1400	1400	1400
Maximum kinematical viscosity of single-phase fluid, for which pump may be operated without change of its head and efficiency	mm ² /s	1	1	1	1
Maximum mass concentration of solid particles (with relative hardness not more than 5 points by Mohs scale)	g/l	0.2	0.2	1	1
Maximum content of associated gas (by volume) at intake of pumps of modifications differing by availability of unit acting on gas fraction	-	25	25	25	25
	G	55	55	55	55
	D	40	40	40	40
Maximum concentration of hydrogen sulfide	g/l	0.05	0.05	1.25	1.25
Maximum temperature of pumped fluid	°C	90	120	90	120
Maximum content of associated water	%	99	99	99	99
Hydrogen index of associated water	pH	6.0÷8.5	6.0÷8.5	6.0÷8.5	6.0÷8.5

Note: On the Customer's request, special versions of centrifugal pumps may be manufactured – pumps with maximum temperature of pumped fluid of 150°C.

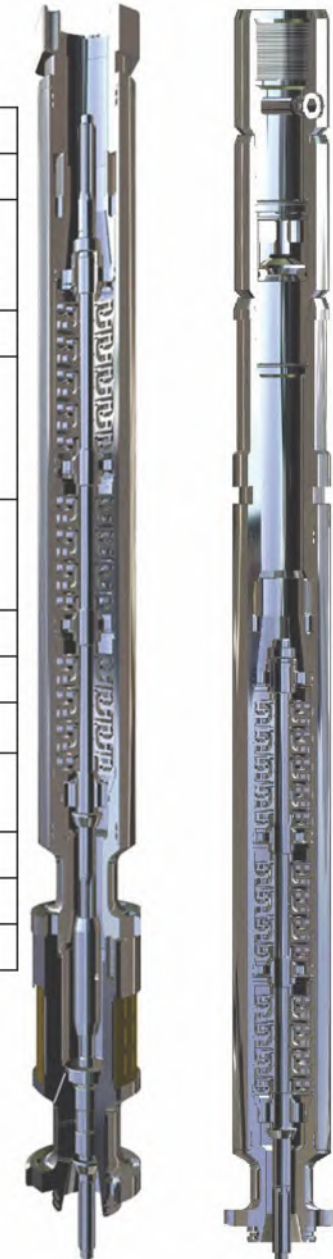



Versions

The centrifugal pumps are manufactured in standard, heat-resistant, wear-resistant and heat-wear-resistant versions, version with increased heat resistance and wear-resistant version with increased heat resistance.

Designs

The main technical solutions aimed at improving reliability of centrifugal pumps include the following:

- the axial supports of shafts are excluded from pump sections. The axial force acting on pump shafts is taken by reinforced axial support of protector;
- the wear-resistant version uses two-support impellers and diffusers made of wear-resistant cast iron (Ni-resist iron), radial bearings with bushes made of hard alloy or silicon carbide, which provide operation of pump at high concentrations of mechanical impurities;
- the pumps may be provided with combined-design stages having diffuser made of grey modified cast iron and impeller made of polymer.



CENTRIFUGAL PUMPS

The polymeric impellers provide:

- corrosion resistance
- high cleanness of flow passages, unavailability of voltaic pairs, low level of scale build-up;
- a low weight of impellers reduces rotor mass, decreases wear of shaft radial bearings and support surfaces of diffusers;
- radial bearings with bushes of hard alloy or silicon carbide are installed in each pump section between group of working parts. A groove is provided on outer surface of the radial bearings with installed rubber ring making possible to prevent leakage of liquid through clearances between housing and diffusers;
- the design of lower heads provides protection of cable from damage from contact with casing string;
- the shafts are manufactured of high-strength steel with material yield strength up to 110 kgf/mm²;
- use of durable fasteners.

The centrifugal pumps have no axial support. The axial load transmitted by pump shaft is taken by protector shaft with reinforced axial support. Design versions of centrifugal pumps with axial supports in sections are also available.

The design of centrifugal pumps makes it possible to supplement them with gas separator, disperser, gas separator-disperser, in order to be able to use the plants in oil wells with high gas/oil ratio.



MOTORS

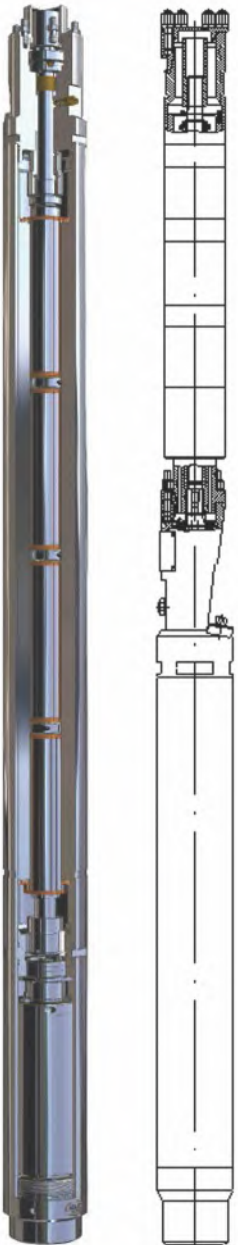

The oil-filled squirrel-cage two-pole three phase submersible asynchronous electric motors with continuous mode of operation S1 to GOST 183 from AC mains with frequency of 50 Hz (motors) are designed to be used as a drive of centrifugal pumps used for pumping out formation fluid (oil, associated water and associated gas) from oil wells with deflection angle in the place of suspension not more than 60° . The rated value of environmental climatic factors during operation shall meet version B* to GOST 15150.

The motors consist of the following assembly units: one or several electric motors (sections) and protector.

The motors with submersible telemetry system consist of the following assembly units: one or several electric motors (sections), protector and ground-installed part of submersible telemetry system.

The following reliability parameters are specified for motors:

- mean time to failure – 20000 hours;
- mean time to overhaul – 25000 hours;
- mean service life – 5 years;
- shelf life – 24 months.

The guaranteed operation period is 18 months from the date of putting into operation within guaranteed shelf life.

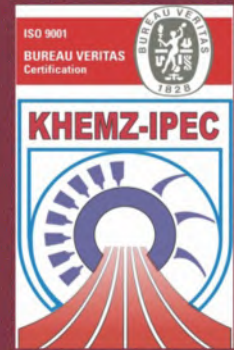



ELECTRIC MOTORS

Range of manufactured electric motors

The electric motors are manufactured with housing diameter of 103, 117 and 123 mm.

Range of powers of electric motors with housing diameter of 103 mm:

- one-section: 22, 28, 32, 40, 45, 50, 56, 63 kW;
- two-section: 63, 75, 90 kW;
- three-section: 110, 125, 140 kW.

Range of powers of electric motors with housing diameter of 117 mm:

- one-section: 22, 28, 32, 36, 40, 45, 50, 56, 63, 70, 80, 90, 100, 110, 125 kW;
- two-section: 140, 160, 180, 200, 220, 250 kW.

Range of powers of electric motors with housing diameter of 123 mm:

- one-section: 90, 100, 125, 160 kW;
- two-section: 180, 200, 250, 320 kW.

Versions

The electric motors are manufactured in standard, heat-resistant version and version with increased heat resistance.

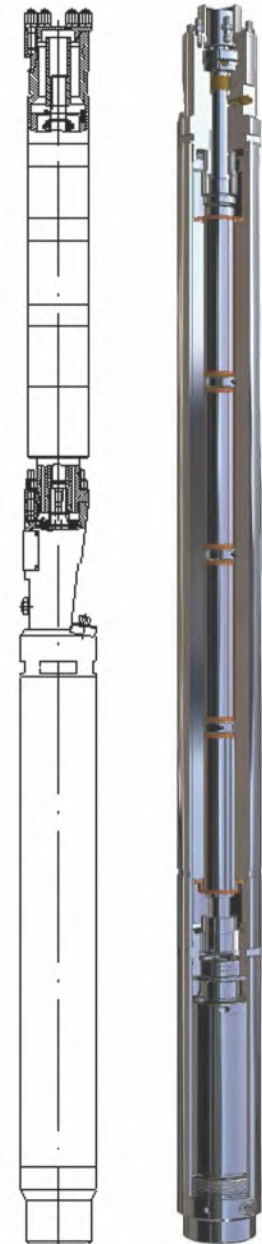

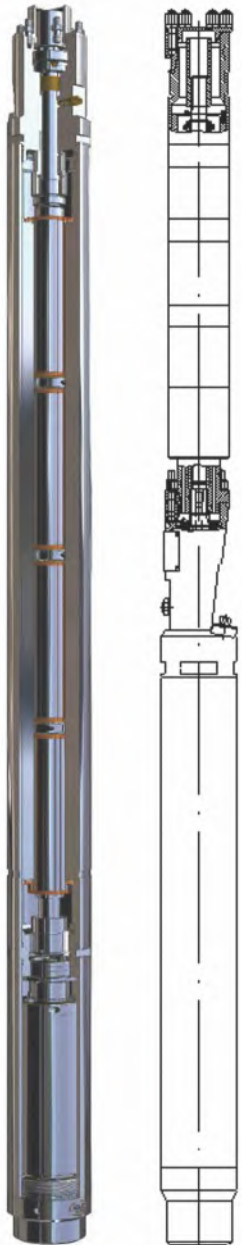

Design

The main technical solutions aimed at improving reliability of electric motors include the following:

- electric motors with housing diameter of 117 mm of M5 retrofit have stator magnetic circuit with 24 closed slots;
- the design provides for key, which fixes the stator magnetic circuit in relation to electric motor housing and absolutely excludes the possibility its turning during operation;
- the stator winding is obtained with the use of wire manufactured by “Von Roll Schweiz AG” and having insulation of “Du Pont” polyamide-fluoroplastic film with heat resistance of 200°C;
- the stator winding is impregnated by vacuum method with HFP 2053 high-temperature varnish, which excludes displacement of conductors in slots and winding overhangs, and in relation to each other, prevents breakdown of winding insulation and increases motor thermal endurance to class C;
- the magnetic oil-cleaning system (filter) simplifies design of the lower housing and facilitates servicing the equipment during minor and major repair;



ELECTRIC MOTORS

- use of self-positioning thrust bearings with metal-fluoroplastic friction surface and spherical support surface;
- thrust collars with friction surface of cast tungsten carbide making possible to increase service life of thrust bearing;
- shaft protective sleeves are installed in the places of location of radial friction bearings, which excludes wear of shaft working surface, extends shaft service life, increases reliability and simplifies repair works;
- the current conductor block is made of polyphenylene sulfide PPS-4 having heat resistance of 260°C and has a clamp to be secured in the electric motor head;
- the rotor bearings are manufactured of non-magnetic material and have locking damper devices excluding their rotation in the stator bore and reducing vibration level of electric motor;

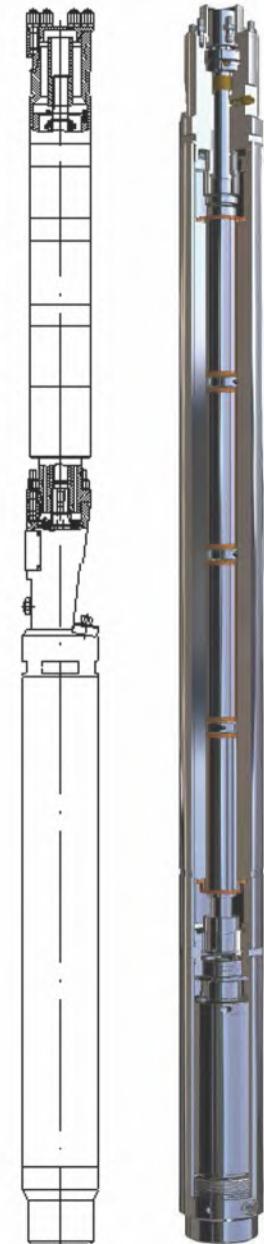

ELECTRIC MOTORS

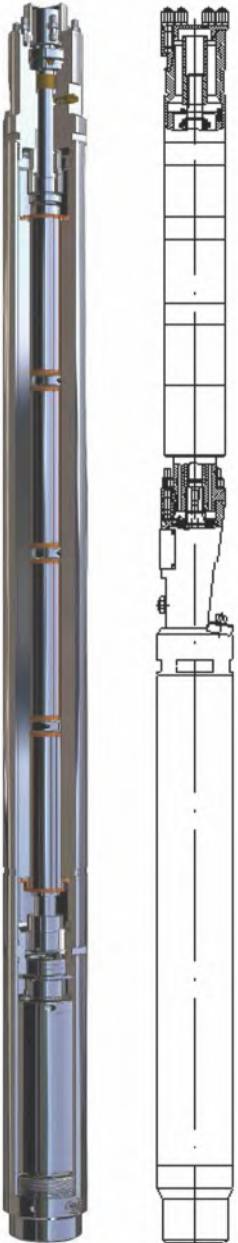

- use of high-strength shafts with material yield strength of 110 kgf/mm²;
- the electric motors have a higher starting torque in comparison with competitive ones, which makes it easy to start up the pump plant;
- the electric motors come complete with single-housing three-chamber motor protector.

Medium where electric motors are to be operated

Ambient temperature Not more than +135°C

Hydrostatic pressure in the neighborhood of electric motor Not more than 400 kgf/cm²

Concentration of solid particles (with micro-hardness of solid particles up to 5 points by Mohs scale) Not more than 1 g/l

Concentration of hydrogen sulfide Not more than 0.01 g/l

Note: On the Customer's request, special versions of electric motors may be manufactured – motors operated at ambient temperature of 150°C.





ELECTRIC MOTORS

Types and specifications of electric motors

The main technical parameters of standard electric motors are pointed out in the tables below.

On the Customer's request, the electric motors may be manufactured in heat-resistant version, increased heat-resistant version, with telemetry system or with possibility of connection of telemetry system: "Electron-TMS", "SKAD-2002-SKS", "IR3 TMS", "TM-01-03" and others (without replacement of electric motor housing parts).

Main technical parameters of standard one-section electric motors with housing diameter of 103 mm

Electric motor (section) type	Power, kW	Voltage, V	Current, A
ED22-103	22	690	27,5
ED28-103	28	870	28
ED32-103	32	1000	27,5
ED32-103M1	32	870	32
ED40-103	40	1020	34
ED45-103	45	1050	37
ED50-103	50	1350	32
ED56-103	56	1400	35
ED63-103M1	63	1400	40

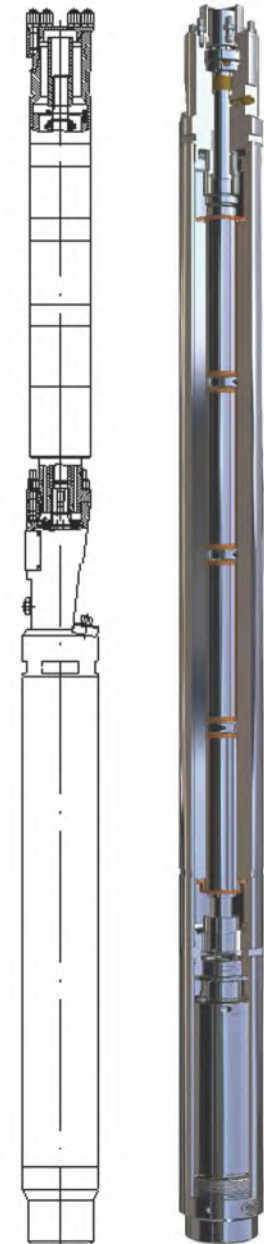

ELECTRIC MOTORS

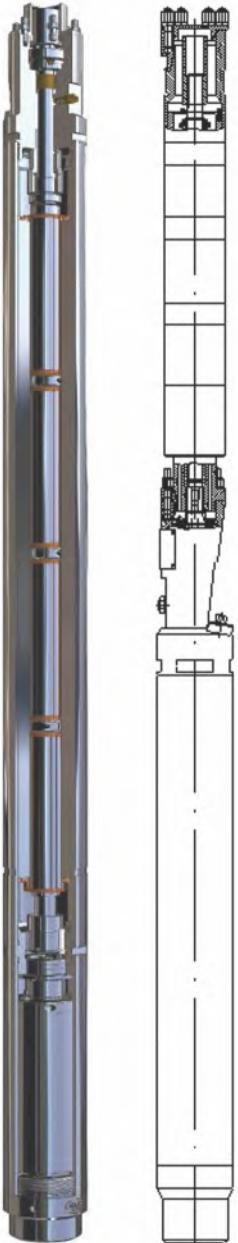

Main technical parameters of normal two-section and three-section electric motors with housing diameter of 103 mm

Electric motor (section) type	Power, kW	Voltage, V	Current, A
ED32-103V	31,5	870	32
ED32-103N		880	
Assembled	63	1750	32
ED35-103V	35	915	
ED40-103N	40	1060	32
Assembled	75	1975	
ED45-103V	45	1075	35,5
ED45-103N		2150	
Assembled	90	2150	39
ED45-103M1V	45	980	
ED45-103M1N	90	990	39
Assembled		1970	
ED36-103V	36	605	51
ED36-103S		640	
ED38-103N	38	640	57
Assembled	110	1850	
ED41-103V	41,1	625	57
ED41-103S		650	
ED41-103N	42,7	650	56
Assembled	125	1900	
ED63-103M1V	62,5	980	56
ED63-103M1N		1000	
Assembled	125	1980	56
ED47-103V	47	733	
ED47-103S		2200	
ED47-103N	140	2200	56
Assembled		2200	

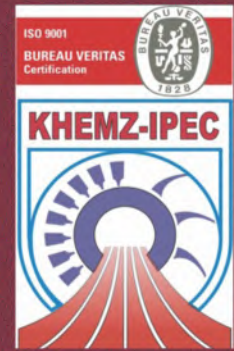



ELECTRIC MOTORS

Main technical parameters of standard one-section electric motors with housing diameter of 117 mm with closed slot

Electric motor (section) type	Power, kW	Voltage, V	Current, A
ED22-117M5	22	720	24
ED28-117M5	28	910	24,5
ED32-117M5	32	1050	24,5
ED36-117M5	36	1240	23,5
ED40-117M5	40	1280	25
ED45-117M5	45	1450	25
ED50-117M5	50	1600	25
ED56-117M5	56	1820	24,5
ED63-117M5	63	2000	25
ED63-117M5M1	63	1400	36
ED70-117M5	70	2150	26
ED80-117M5	80	2010	32
ED90-117M5	90	1900	38
ED90-117M5M1	90	2170	33
ED100-117M5	100	2060	39
ED110-117M5	110	1910	46
ED125-117M5	125	2220	46

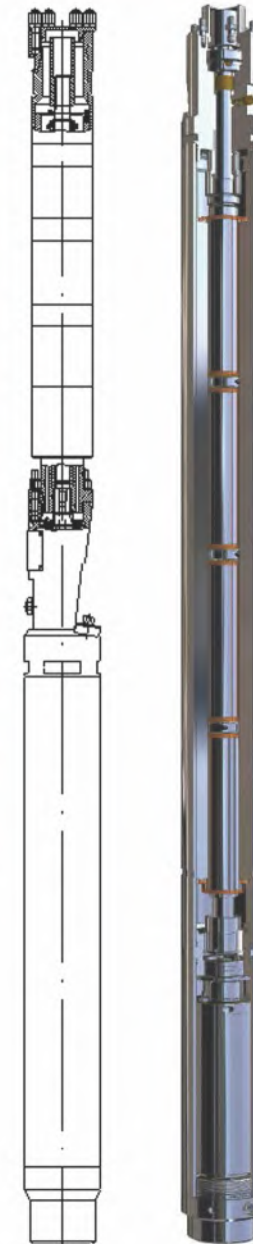

ELECTRIC MOTORS

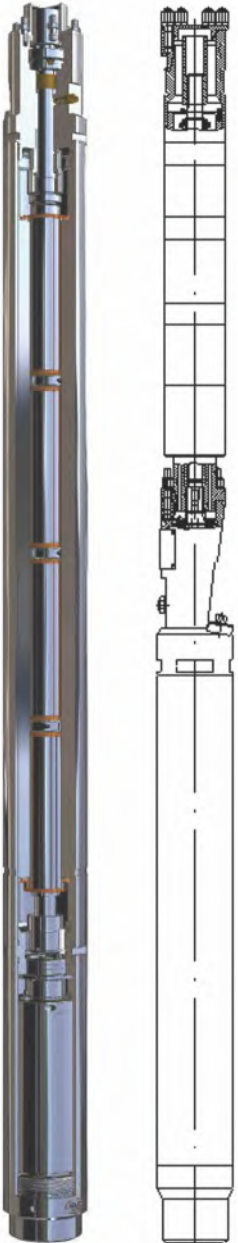

Main technical parameters of standard two-section electric motors with housing diameter of 117 mm with closed slot

Electric motor (section) type	Power, kW	Voltage, V	Current, A
ED70-117M5V	70	1070	52
ED70-117M5N		1100	
Assembled	140	2170	
ED80-117M5V	80	1000	63
ED80-117M5N		1020	
Assembled	160	2020	
ED90-117M5V	90	935	76
ED90-117M5N		965	
Assembled	180	1900	
ED100-117M5V	100	1000	79
ED100-117M5N		1030	
Assembled	200	2030	
ED110-117M5V	110	1100	80
ED110-117M5N		1130	
Assembled	220	2230	
ED125-117M5V	125	1240	80
ED125-117M5N		1290	
Assembled	250	2530	

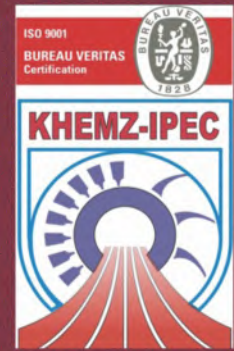



ELECTRIC MOTORS

Main technical parameters of standard one-section and tow-section electric motors with housing diameter of 123 mm

Electric motor (section) type	Power, kW	Voltage, V	Current, A
One-section (single) electric motors with housing diameter of 123 mm			
ED90-123M3	90	2150	33
ED90-123	90	1980	36
ED100-123	100	2130	37
ED125-123	125	2150	46
ED160-123	160	2550	50
Two-section electric motors with housing diameter of 123 mm			
ED90-123V	90	960	74
ED90-123N		1000	
Assembled	180	1960	
ED100-123V	100	1040	75
ED100-123N		1060	
Assembled	200	2100	
ED125-123V	125	1220	80
ED125-123N		1240	
Assembled	250	2460	
ED160-123V	160	1460	86
ED160-123N		1490	
Assembled	320	2950	

Notes:

1. Electric motors with housing diameter of 103 mm having code of protector modification and retrofit "D5" come complete with protector of P5M5 type, and those having code of protector modification and retrofit "Д6" come complete with protector of P5M6 type.
2. One-section electric motors with housing diameter of 117 mm having code of protector modification and retrofit "D5" come complete with protector of P5M5 type, and those having code of protector modification and retrofit "D6" come complete with protector of P5M6 type.
3. Two-section electric motor with housing diameter of 117 mm having code of protector modification and retrofit "DA5" come complete with protector of P5AM5 type.
4. Electric motors with housing diameter of 123 mm having code of protector modification and retrofit "D2" come complete with protector of P6M2, and those having code of protector modification and retrofit "D2U114" come complete with protector of P6D2U114 type.

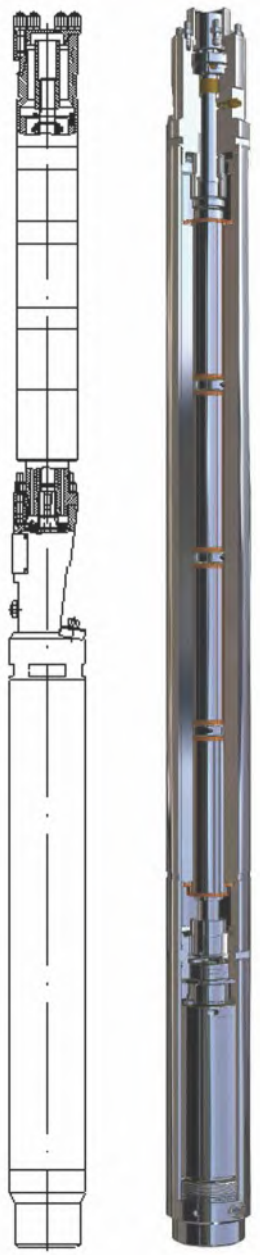

MOTOR PROTECTORS

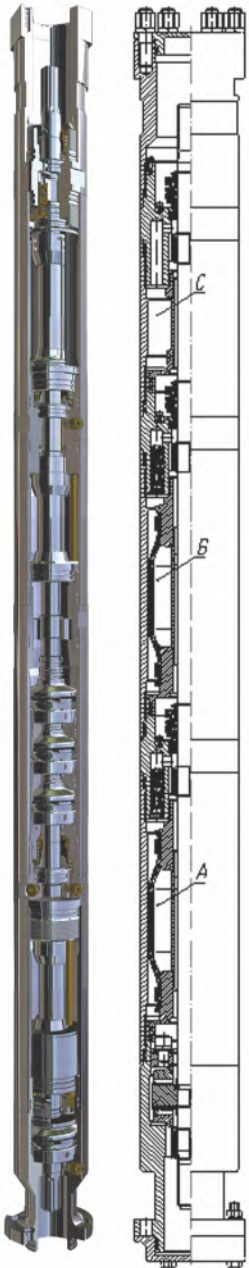

The motor protector is one of the most important units of the motor. It is designed for protection of internal cavities of electric motors from ingress of formation fluid and for compensation of consumption and temperature changes of oil volume.

Medium where motor protectors are to be used

Ambient temperature Not more than $+135^{\circ}\text{C}$

Hydrostatic pressure in the neighborhood of protector Not more than 400 kgf/cm^2

Concentration of solid particles (with micro-hardness of solid particles up to 5 points by Mohs scale) Not more than 1 g/l

Concentration of hydrogen sulfide Not more than 0.01 g/l

Note: On the Customer's request, special versions of motor protectors may be manufactured – with ambient temperature of not more than 150°C .

Versions

The motor protectors are manufactured in standard and heat-resistant version, as well as in version with increased heat resistance.

Design

The main technical solutions aimed at increasing reliability of motor protectors include the following:

- the single-housing motor protectors consist of two tight and one labyrinth chambers (P5M6 – two labyrinth and one tight chamber);

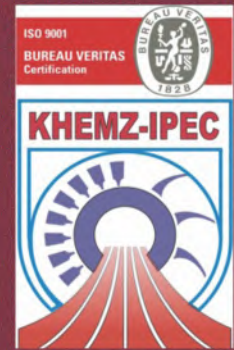



MOTOR PROTECTORS

- each tight chamber has relief devices comprising two bypass valves installed inline, which makes it possible for each chamber to relieve excess pressure to the next cavity with final its relief to annular space. This design of chambers allows using the entire volume of diaphragms for filling with oil, to simplify installation of plant in the well, with retention of high reliability;
- the motor protectors have the third labyrinth chamber that prevents for a long time ingress of associated gas and formation fluid into tight chamber, that is, the cavity above the upper diaphragm;
- the pressure of formation fluid in electric motor is equalized through axial openings in nipples, labyrinths and protector flexible diaphragms;
- the used sealing components and diaphragms are made of rubber resistant to action of high temperature, and housing parts contacting environmental medium are made of materials sufficiently resistant to action of corrosion;

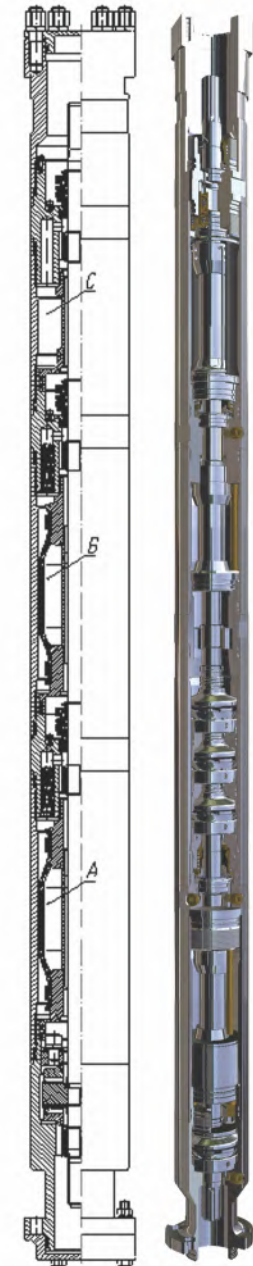

MOTOR PROTECTORS

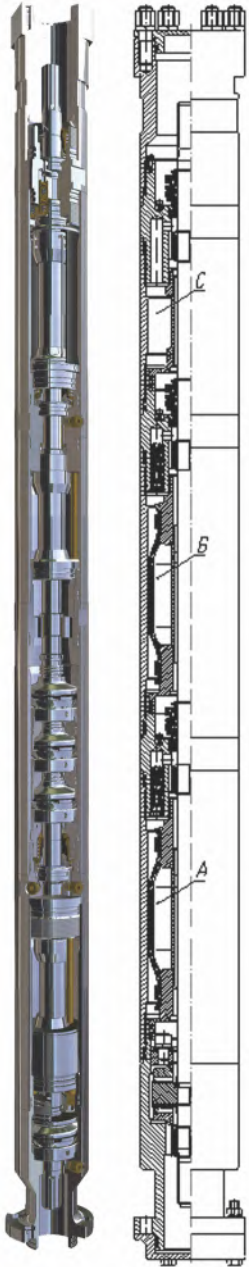

- friction in friction bearings takes place along sleeves on the shaft protecting the latter from wear;
- self-positioning thrust bearings are used
- increased-strength shafts are used, which have yield strength of 110 kgf/mm²;
- the design of three-chamber single-housing motor protectors reduces labor content of preparatory works at user's hire-and-repair shop, simplifies the process of installation of electric submersible pump unit in the well, enhances reliability of motor operation as a whole.



Types and technical specifications of motor protectors

Protector type	Main characteristics	Design features
Protector P5M5	Oil volume: 7.6 l. Shaft diameter: 25 mm Transmitted power: not more than 280 kW at rotational speed of 3000 rpm (synchronous). Outside diameter: 92 mm	Diaphragm P92D1-01-039: 2 pcs Face seal UR25V5: 3 pcs
Protector P5M6	Oil volume: 6 l Shaft diameter: 25 mm Transmitted power: not more than 280 kW at rotational speed of 3000 rpm (synchronous). Outside diameter: 92 mm Axial load from pump shaft: not more than 750 kg	Diaphragm P5DL-01-40-003: 1 pc Face seal UR25V5: 3 pcs
Protector P5AM5	Oil volume: 8.5 l. Shaft diameter: 35 mm Transmitted power: not more than 350 kW at rotational speed of 3000 rpm (synchronous). Outside diameter: 103 mm	Diaphragm P92D1-01-039: 2 pcs Face seal UR35V5: 3 pcs
Protector P6M2	Oil volume: 8.6 l Shaft diameter: 35 mm Transmitted power: not more than 350 kW at rotational speed of 3000 rpm (synchronous). Outside diameter: 103 mm	Diaphragm P92D1-01-039: 2 pcs Face seal UR35V5: 3 pcs
Protector P6M5	Oil volume: 9.2 l Shaft diameter: 35 mm Transmitted power: not more than 770 kW at rotational speed of 3000 rpm (synchronous). Outside diameter: 114 mm	Diaphragm P114D1-01-040: 2 pcs Face seal UR35V5: 3 pcs
Protector P6D2U114	Oil volume: 9.2 l Shaft diameter: 35 mm Transmitted power: not more than 770 kW at rotational speed of 3000 rpm (synchronous). Outside diameter: 114 mm Axial load from pump shaft: not more than 1200 kg	Diaphragm P114D1-01-040: 2 pcs Face seal UR35V5: 3 pcs

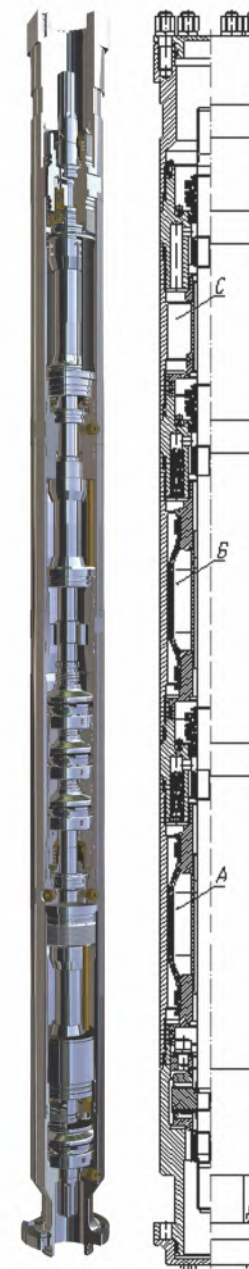

Example of overall and mounting dimensions, and (net) mass for some types of motors

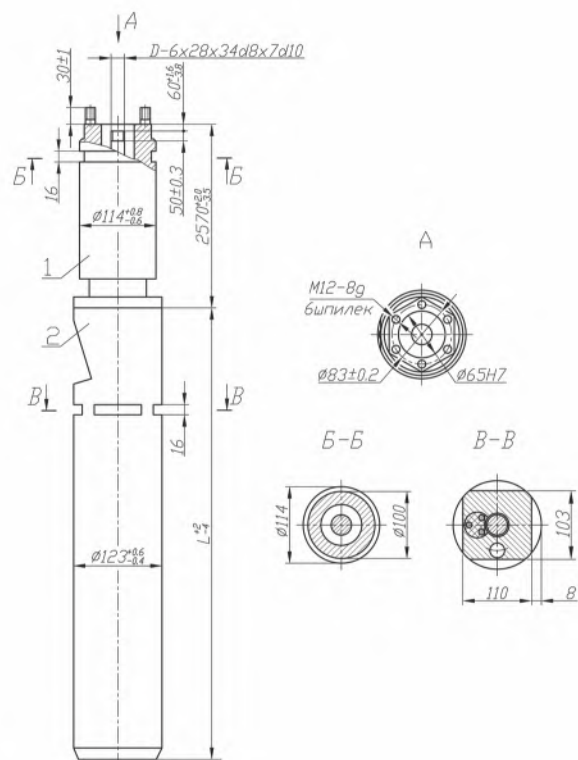

1. Motor protector
2. Electric motor

PEDU90-123M3D5D*:

$L = 7265$ mm

$m = 726$ kg.



Example of overall and mounting dimensions, and (net) mass for some types of motors

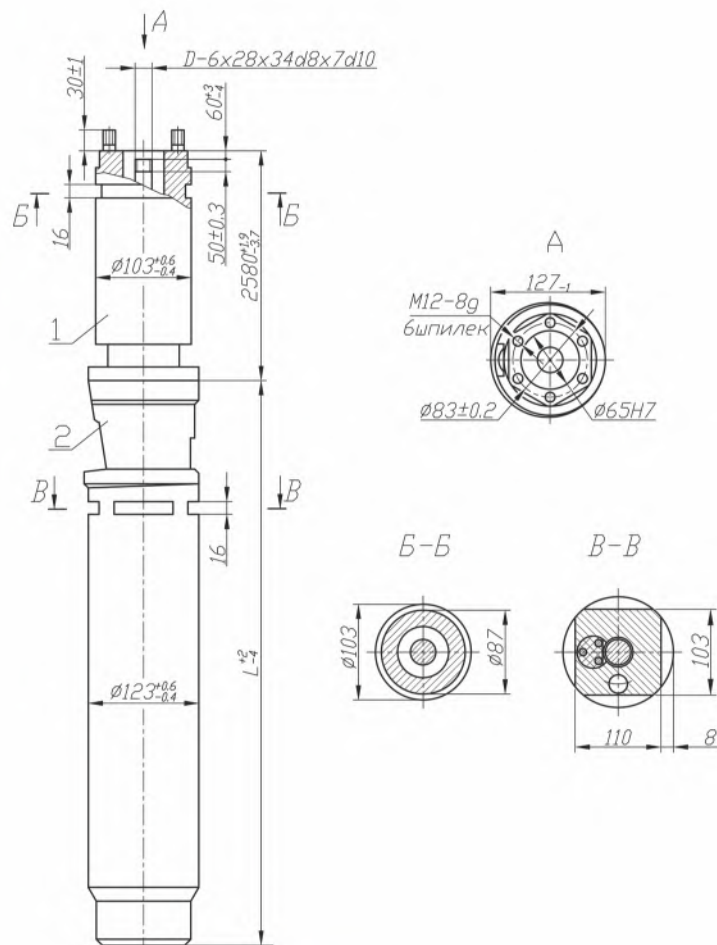

1. Motor protector
2. Electric motor

Motor type	L, mm	Mass, kg
PEDU100-123D2B*	6325	635
PEDU 125-123D2B*	7265	722
PEDU 160-123D2B*	8205	807



Sealed Metering Plunger Pump Units

Sealed metering plunger pumping units (hereinafter - metering pumps) are widely used in a wide variety of industries: petrochemical and oil and gas, food, pharmaceutical, agriculture, energy and many others. The main advantage of metering pumps is their ability to accurately regulate and maintain the required amount of supplied liquid in any system. Corrosion-resistant stainless steels are used in the flow parts of the pumps, which determines their resistance to most aggressive chemical media.

Their distinctive feature and main advantage is the complete tightness of the pumped liquid in relation to the environment. **The seal in such a pump does not require maintenance during operation.** The pumps are applicable in technological processes where leaks of the pumped medium are unacceptable.

Model **ГН (ГНР, ГНРЕ)** sealed pumps are designed for pumping liquids and suspensions, including toxic and aggressive ones.

Model **ГН** pumps provide adjustment of the flow by changing the length of the plunger stroke manually when the pump is stopped.

Model **ГНР** pumps regulate flow control by manually changing the length of the plunger stroke, both while the pump is running or stopped.

In addition to manual adjustment on the go, model **ГНРЕ** pumps are equipped with flow control by changing the speed of the electric motor. Adjustment can be carried out remotely. It is possible to organize an automatic system that maintains a given feed level.

Sealed Metering Plunger Pump Units

Metering pumps are modular in design. Their main components are drive, coupling, electric motor, and hydraulic part.

Modular design of the hydraulic part allows upgrading the metering pumps in operation to give a new quality, i.e. hermeticity. In this way, LP pumps of any manufacturers can be upgraded.

The upgrading consists in replacing the classic plunger hydraulic part with a sealed one and using the old drive, which allows significant savings.

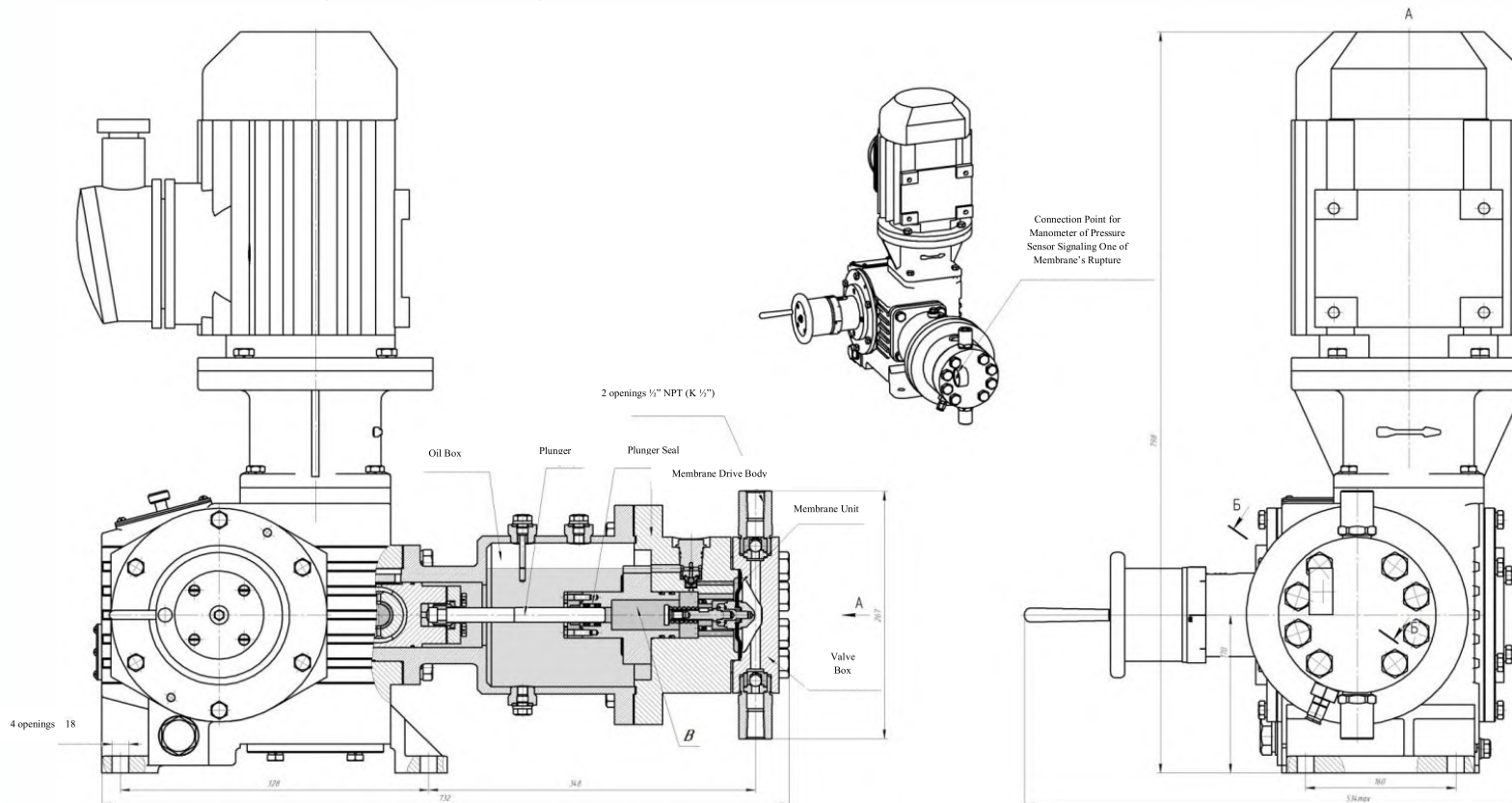
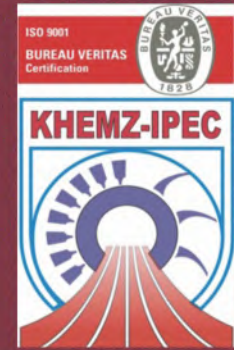



Sealed Metering Plunger Pump Units

*The main parametric range of pumps ГН (ГНР, ГНРЕ)
with electric motor power of 0,25 kW*

Dimension Type	Feed, m ³ /s (l/h)	Discharge Pressure, MPa (kgf/cm ²), no more	Electric Motor Power, kW
2,5/400	6,94x10 ⁻⁷ (2,5)	40 (400)	0,25
4/250	1,11x10 ⁻⁶ (4,0)	25 (250)	
6,3/160	1,75x10 ⁻⁶ (6,3)	16 (160)	
10/100	2,78x10 ⁻⁶ (10)	10 (100)	
16/63	4,44x10 ⁻⁶ (16)	6,3 (63)	
25/40	6,94x10 ⁻⁶ (25)	4,0 (40)	
40/25	1,11x10 ⁻⁵ (40)	2,5 (25)	
63/16	1,75x10 ⁻⁵ (63)	1,6 (16)	
100/10	2,78x10 ⁻⁵ (100)	1,0 (10)	
160/6,3	4,44x10 ⁻⁵ (160)	0,63 (6,3)	



*The main parametric range of GH (GHP, GHPE) pumps
with electric motor power of 0,55 u 1,1 kW*

Dimension Type	Feed, m ³ /sec (l/h)	Discharge Pressure, MPa (kgf/sm ²), no more	Electric Motor Power, kW
6,3/630	1,75x10 ⁻⁶ (6,3)	63 (630)	0,55
10/400	2,78x10 ⁻⁶ (10)	40 (400)	
10/630		63 (630)	1,1
16/250	4,44x10 ⁻⁶ (16)	25 (250)	0,55
16/400		40 (400)	1,1
25/160	6,94x10 ⁻⁶ (25)	16 (160)	0,55
25/250		25 (250)	1,1
40/100	1,11x10 ⁻⁵ (40)	10 (100)	0,55
40/160		16 (160)	1,1
63/63	1,75x10 ⁻⁵ (63)	6,3 (63)	0,55
63/100		10 (100)	1,1
100/40	2,78x10 ⁻⁵ (100)	4,0 (40)	0,55
100/63		6,3 (63)	1,1
160/25	4,44x10 ⁻⁵ (160)	2,5 (25)	0,55
160/40		4,0 (40)	1,1
250/16	6,94x10 ⁻⁵ (250)	1,6 (16)	0,55
250/25		2,5 (25)	1,1
400/10	1,11x10 ⁻⁴ (400)	1,0 (10)	1,1



Sealed Metering Plunger Pump Units

*The main parametric range of GH (GHP, GHPE) pumps
with electric motor power of up to 4 kW*

Dimension Type	Feed, m ³ /sec (l/h)	Discharge Pressure, MPa (kgf/cm ²), no more	Electric Motor Power, kW
16/630	4,44x10 ⁻⁶ (16)	63 (630)	1,5
25/400	6,94x10 ⁻⁶ (25)	40 (400)	
40/250	1,11x10 ⁻⁵ (40)	25 (250)	
40/400		40 (400)	3,0 (4,0)
40/630		63 (630)	
63/160	1,75x10 ⁻⁵ (63)	16 (160)	1,5
63/400		40 (400)	3,0 (4,0)
100/100	2,78x10 ⁻⁵ (100)	10 (100)	1,5
100/250		25 (250)	3,0 (4,0)
160/63	4,44x10 ⁻⁵ (160)	6,3 (63)	1,5
160/160		16 (160)	3,0 (4,0)
250/40	6,94x10 ⁻⁵ (250)	4,0 (40)	1,5
250/100		10 (100)	3,0 (4,0)
400/25	1,11x10 ⁻⁴ (400)	2,5 (25)	1,5
400/63		6,3 (63)	3,0 (4,0)
630/16	1,75x10 ⁻⁴ (630)	1,6 (16)	1,5
630/40		4,0 (40)	3,0 (4,0)
1000/10	2,78x10 ⁻⁴ (1000)	1,0 (10)	1,5
1000/25		2,5 (25)	3,0 (4,0)
1600/16	4,44x10 ⁻⁴ (1600)	1,6 (16)	
2500/10	6,94x10 ⁻⁴ (2500)	1,0 (10)	

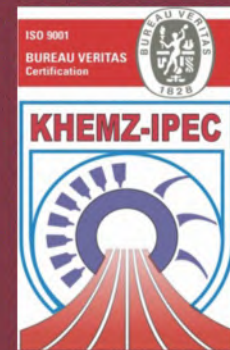



“KHEMZ–IPEC”, PRIVATE JOINT STOCK COMPANY

*15A, Industrialnaya st., Kharkov, 61106, Ukraine
tel., fax: +38 (057) 752-58-81*

*mail1.ipecc@gmail.com office@khemz-ipecc.com
<http://khemz-ipecc.com>
<http://khemz-ipecc.org>*